

Werkzeugkatalog

tool catalogue

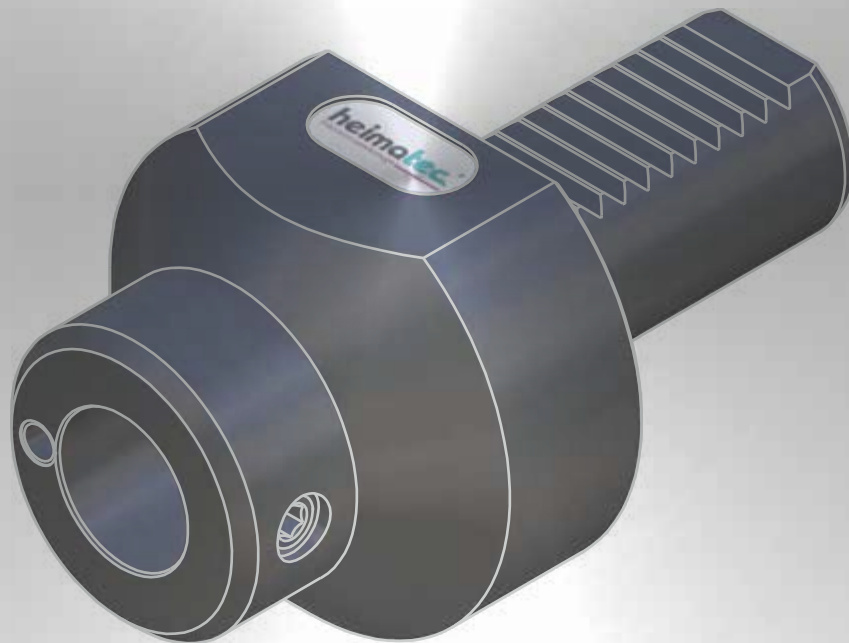

SPINNER

TC 400



Hinweis zu den AGBs:

Diese finden Sie in unserem Internetauftritt unter

www.heimatec.de

Home/Impressum/AGB

Terms and conditions:

You will find them on our website

www.heimatec.com

Home/Imprint/Terms and Conditions

Das Katalog-Werk einschließlich aller seiner Teile ist urheberrechtlich geschützt. Jede Verwertung außerhalb der engen Grenzen des Urheberrechtsgesetzes ist ohne Zustimmung der Rechteeinhaber unzulässig und strafbar. Das gilt insbesondere für Vervielfältigungen, Übersetzungen, Mikroverfilmungen und die Einspeicherung und Verarbeitung in elektronischen Systemen.

heimatec® GmbH behält sich Änderungen technischer Art jederzeit ohne Vorankündigung vor. Dies gilt insbesondere bei Anpassungen an neue oder geänderte internationale Normen oder bei Weiterentwicklungen unserer Produkte oder Herstellungsprozesse.

This catalogue, including all its parts, is protected by copyright. Each use outside the restricted limitations of the Copyright Act is inadmissible and liable to prosecution without the consent of heimatec. This is particularly valid for duplication, translation, microfilming and feeding and processing in electronic systems.

heimatec® GmbH reserves the right of technical changes everytime without advance notice, which is particularly valid for adaptations to new or changed international standards, or to developments of our products or manufacturing processes.

feste Werkzeuge static tool holders

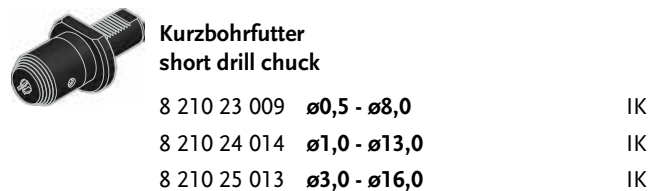
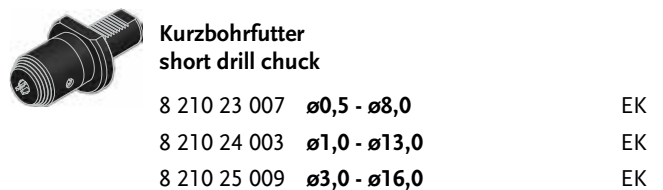
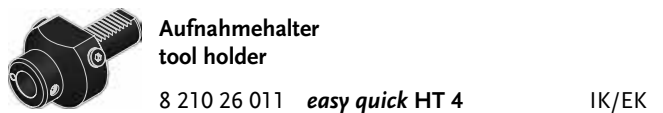
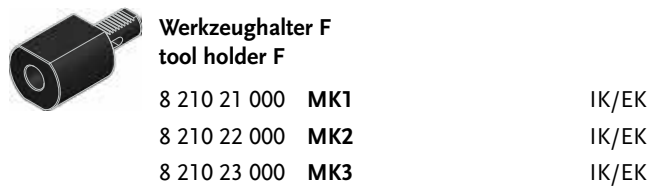
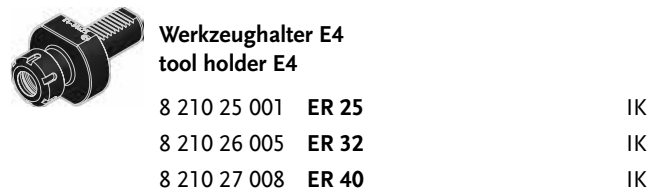
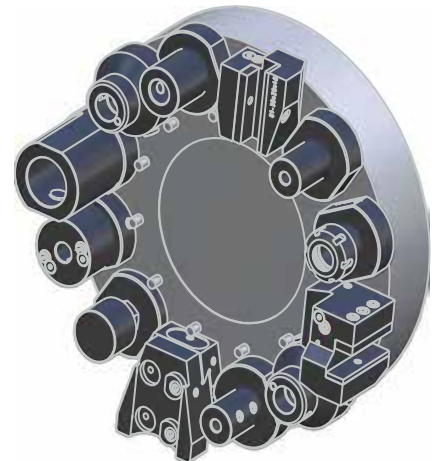
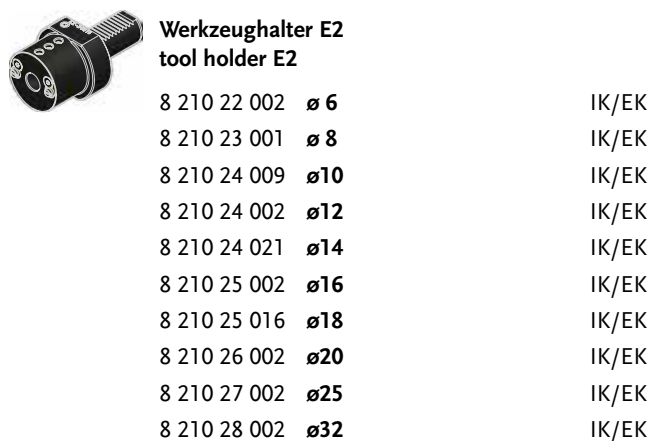
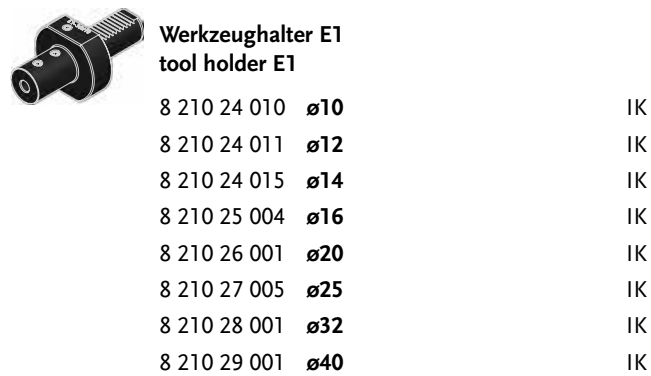
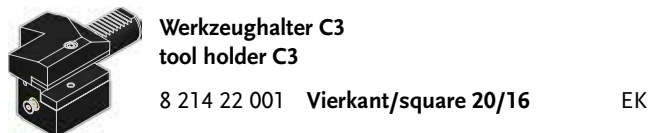
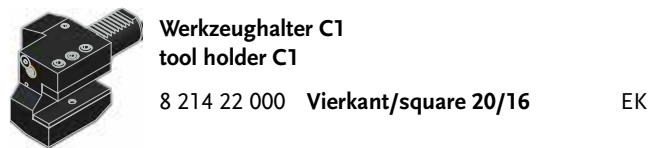
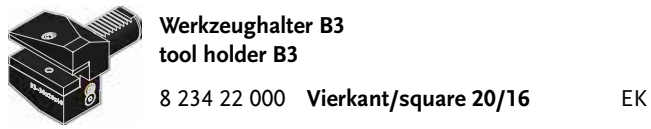
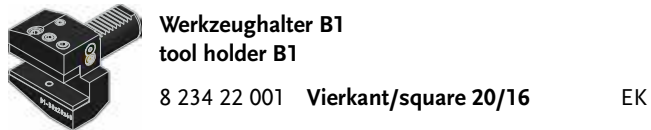

SPINNER TC 400



Werkstoffanschlag
stock stop
8 262 29 000 \varnothing 42



Abstechhalter
cut-off holder
höhenverstellbar / height adjustable
8 320 23 000 **SH 32** EK



Verschlussstopfen Z2
plug Z2
8 200 20 005 **30 S**
8 200 20 000 **30 K**



▶ Weitere Ausführungen auf Anfrage
further versions on request

▶ Zubehör **ZB...***
accessories **ZB...*** 

▶ **easy-quick** 

▶ **u-tec** 

Hauptsitz/headquarters

heimatec® GmbH
Präzisionswerkzeuge
Carl-Benz-Straße 4
D- 77871 Renchen
Postfach 11 36
D- 77867 Renchen
Tel.: +49 (78 43) 94 66 0
Fax: +49 (78 43) 94 66 66
www.heimatec.de
info@heimatec.de

heimatec® Inc.
16 E. Piper Lane Suite 121
USA- 60070 Prospect Heights IL
Tel.: +1 (847) 749 0633
Fax: +1 (847) 749 2445
www.heimatecinc.com
info@heimatecinc.com

heimatec® - Ost, JSC
ul. Kozjubinskogo 4 office 209
RUS- 121351 Moskau
Tel.: +7 (495) 648 69 19
Fax: +7 (495) 648 69 19
www.heimatec-ost.ru
sales@heimatec-ost.ru

